

Proxemics

von lateinisch *proximus* ‚der Nächste‘

„The study of how man unconsciously structures microspace – the distance between men in the conduct of daily transactions, the organization of space in his houses and buildings, and ultimately the layout of his town.“

Edward T. Hall

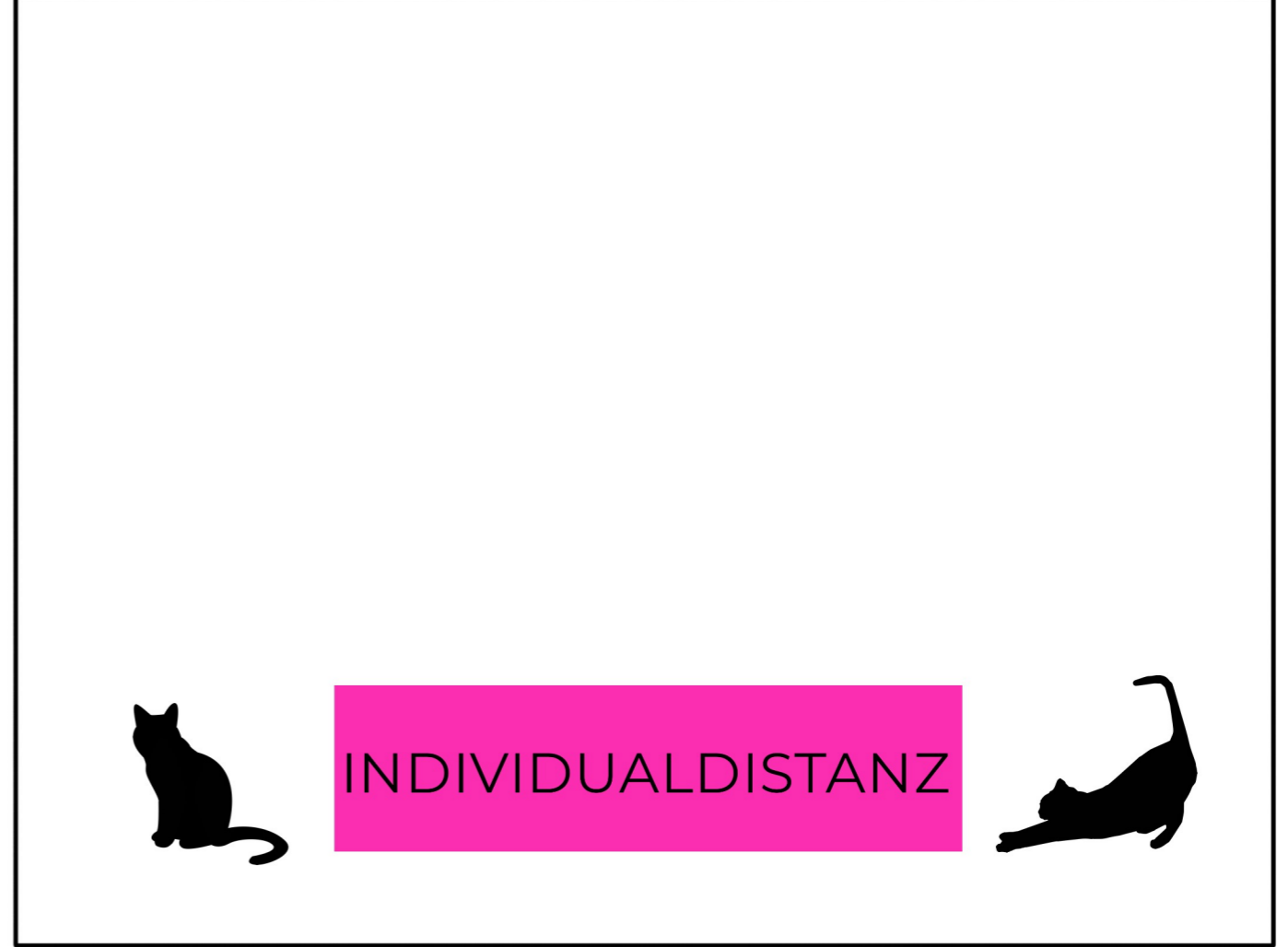
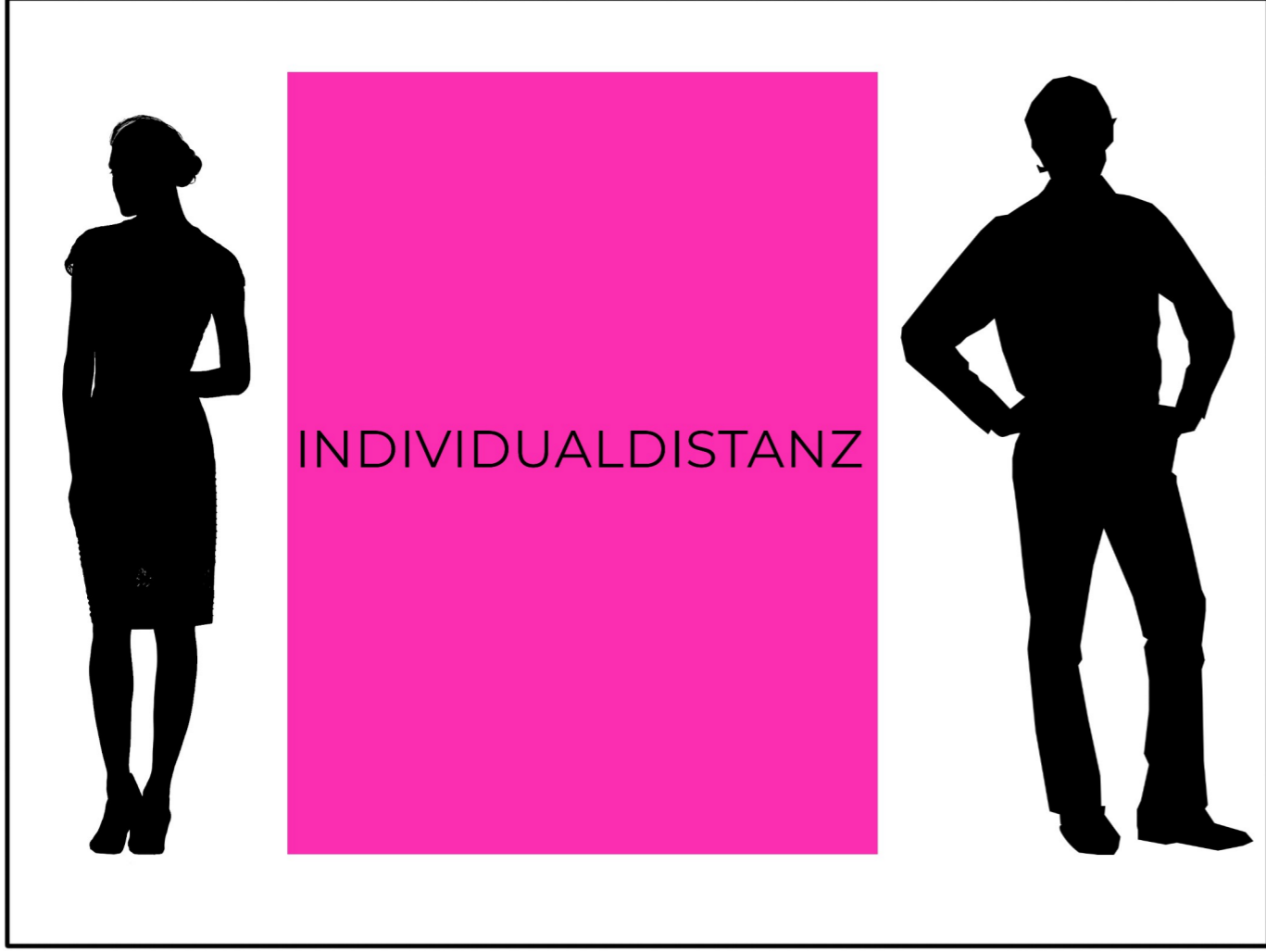

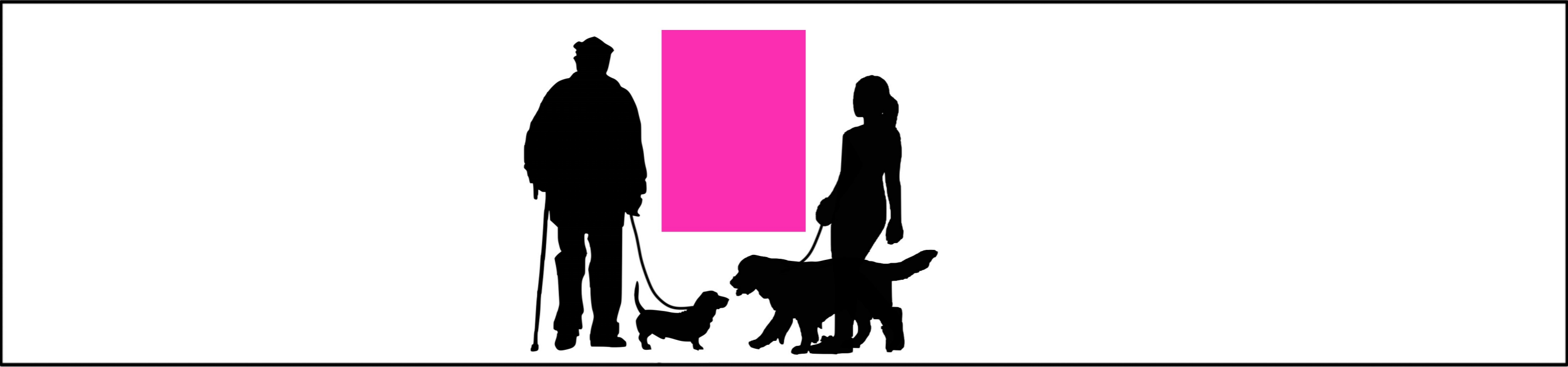
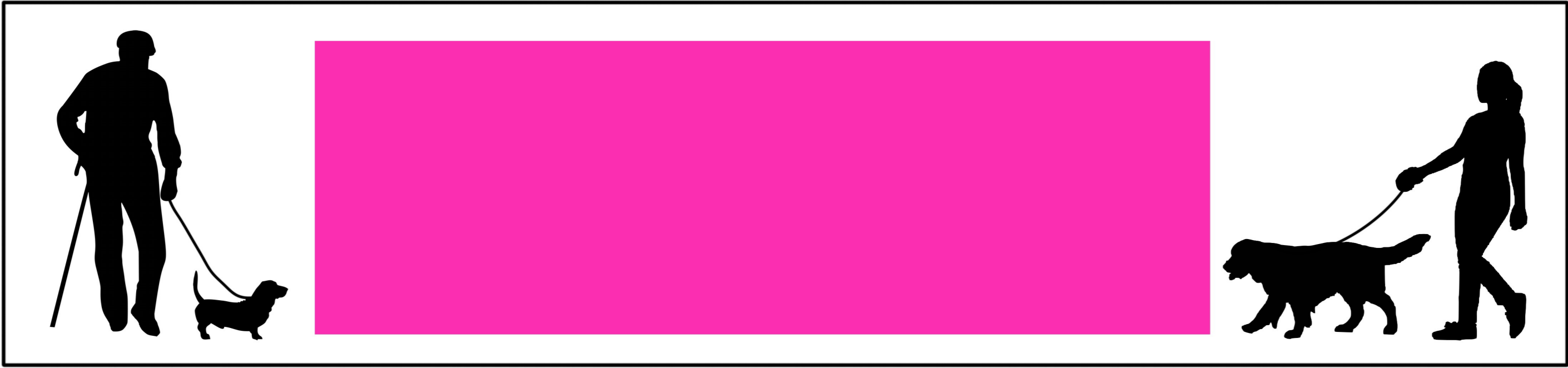

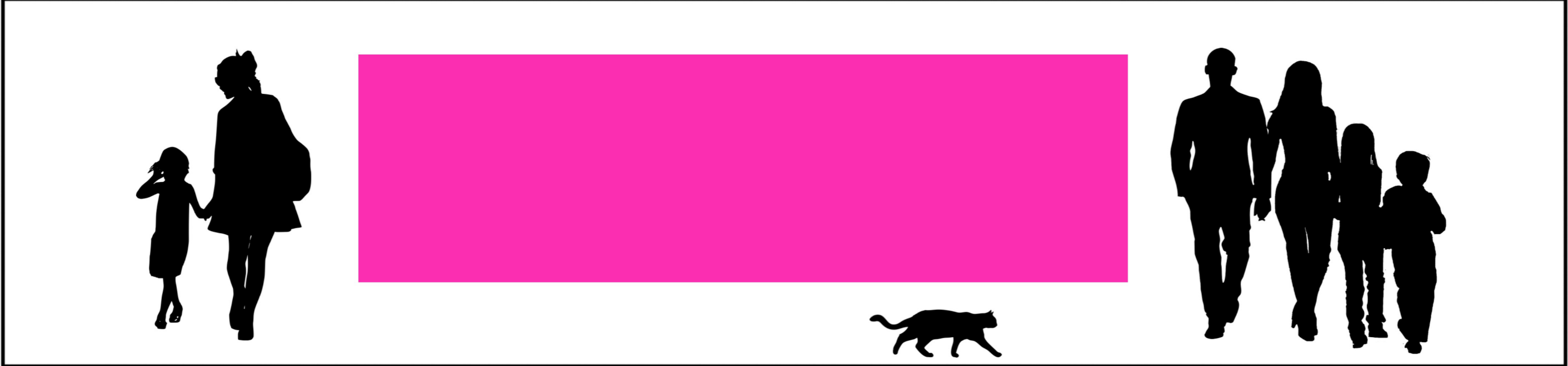
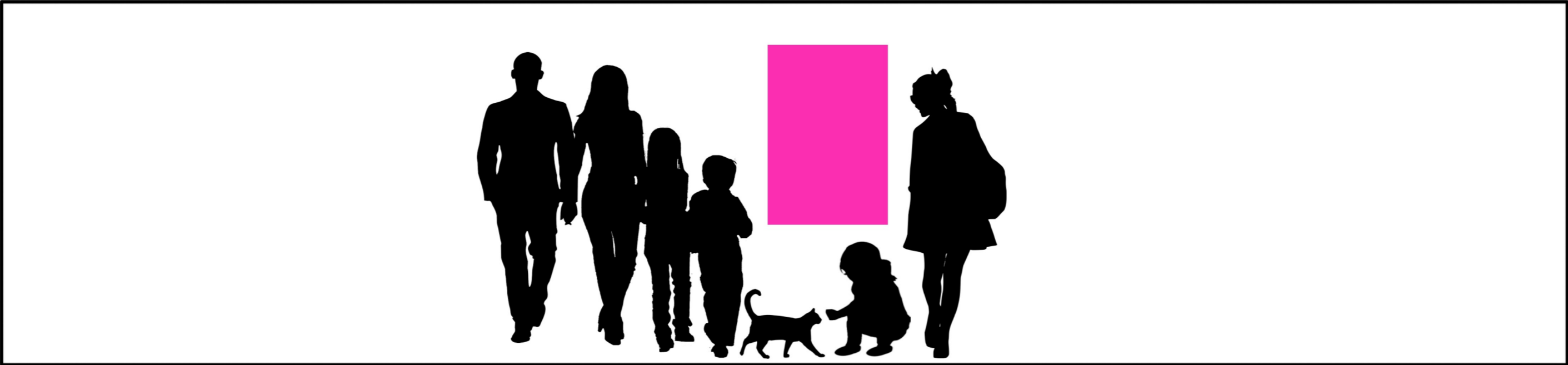
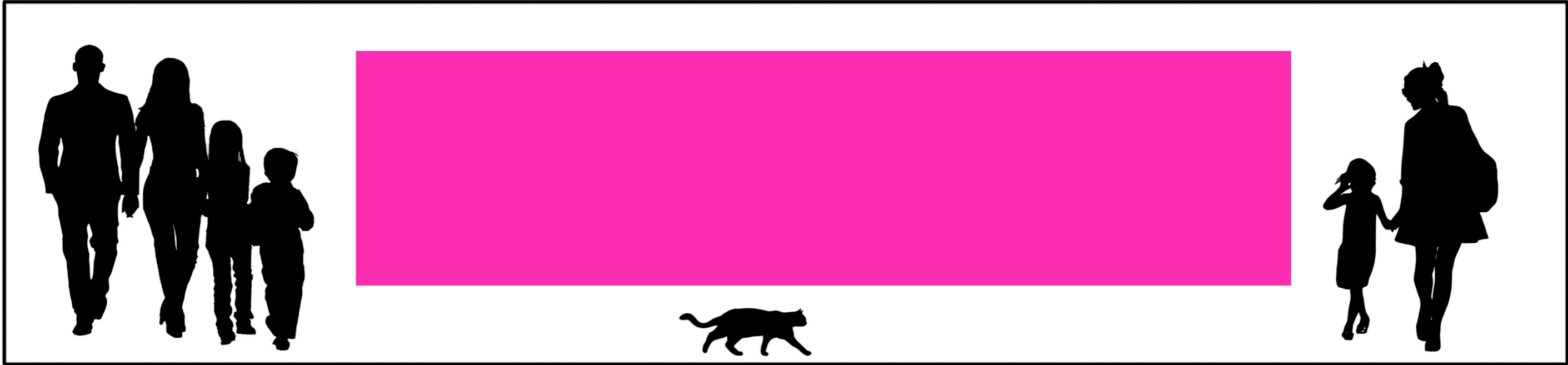

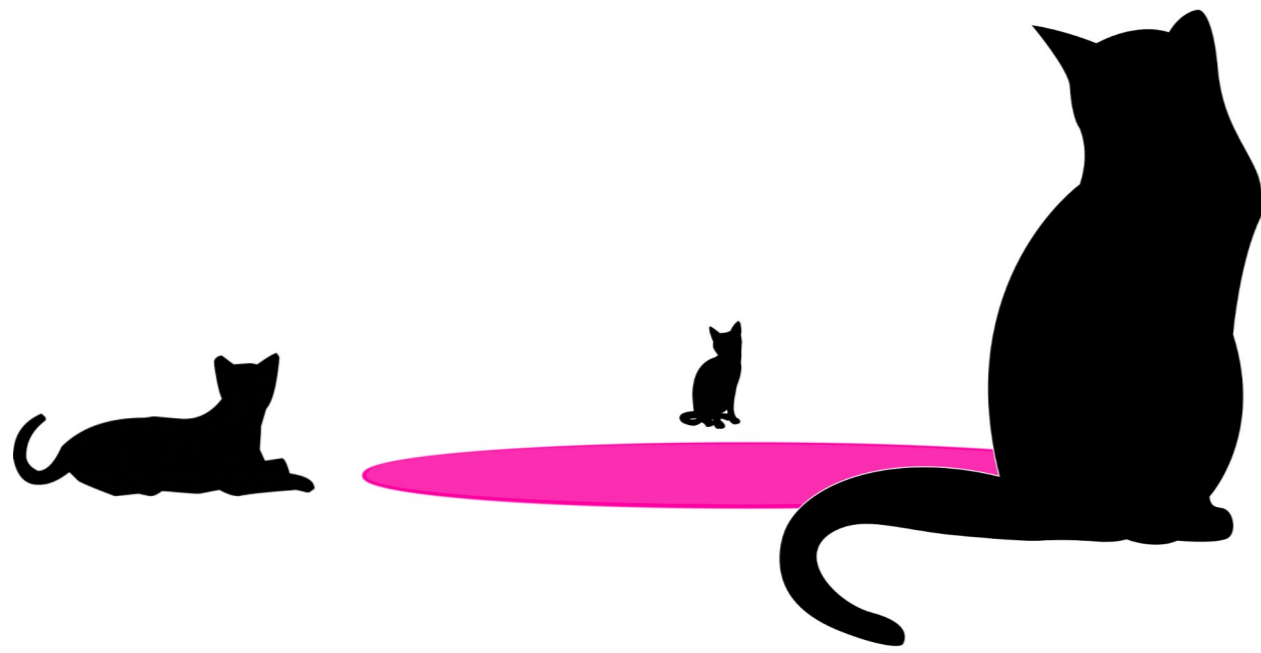

„CatTalk“

Umsetzbares Sinnbild einer Begegnung

Auch Katzen treffen sich an manchen Orten, um in angemessenem Abstand zueinander, gemeinsam miteinander zu sitzen. Nach einer gewissen Zeit gehen sie wieder ihre Wege.

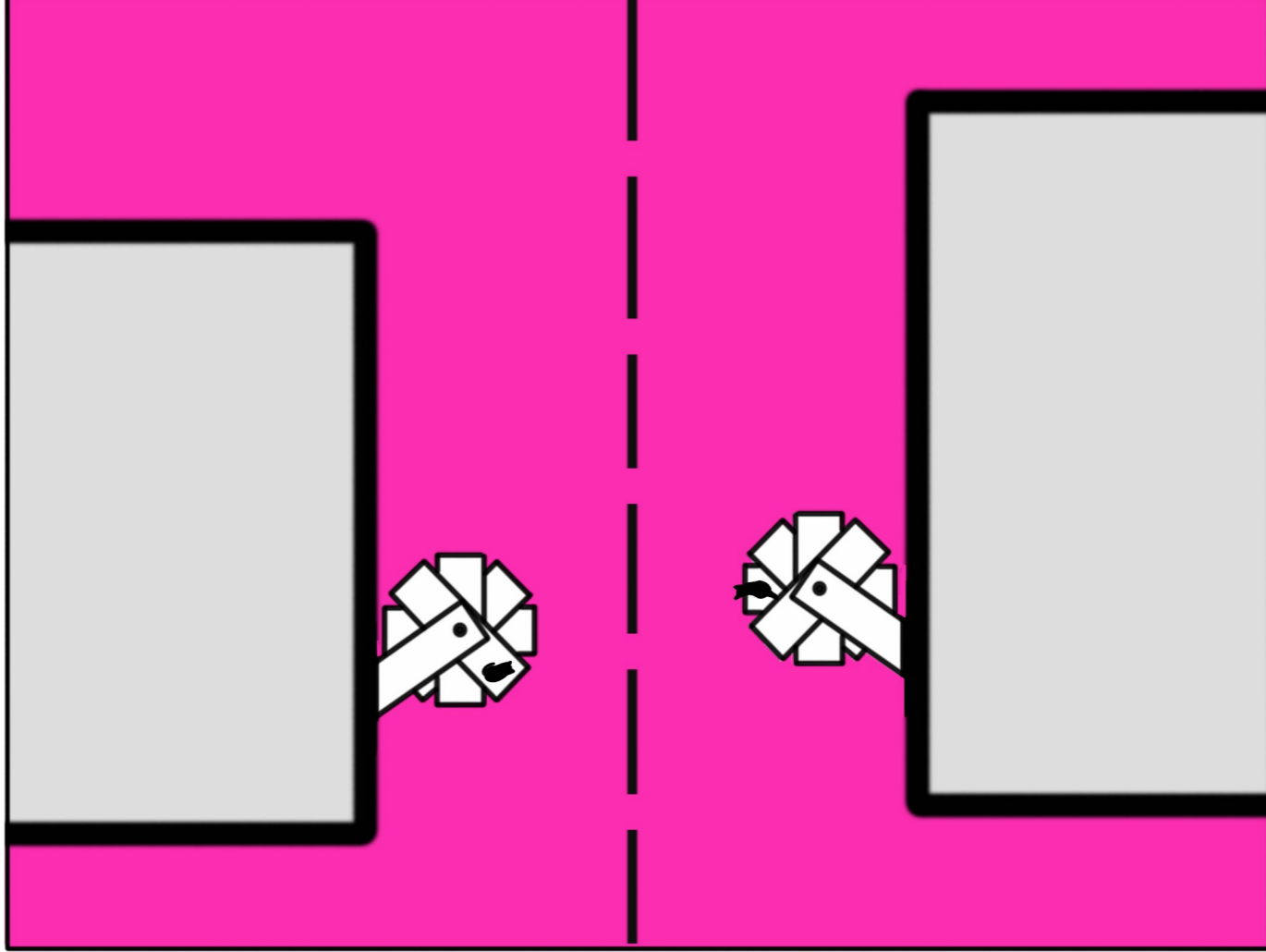
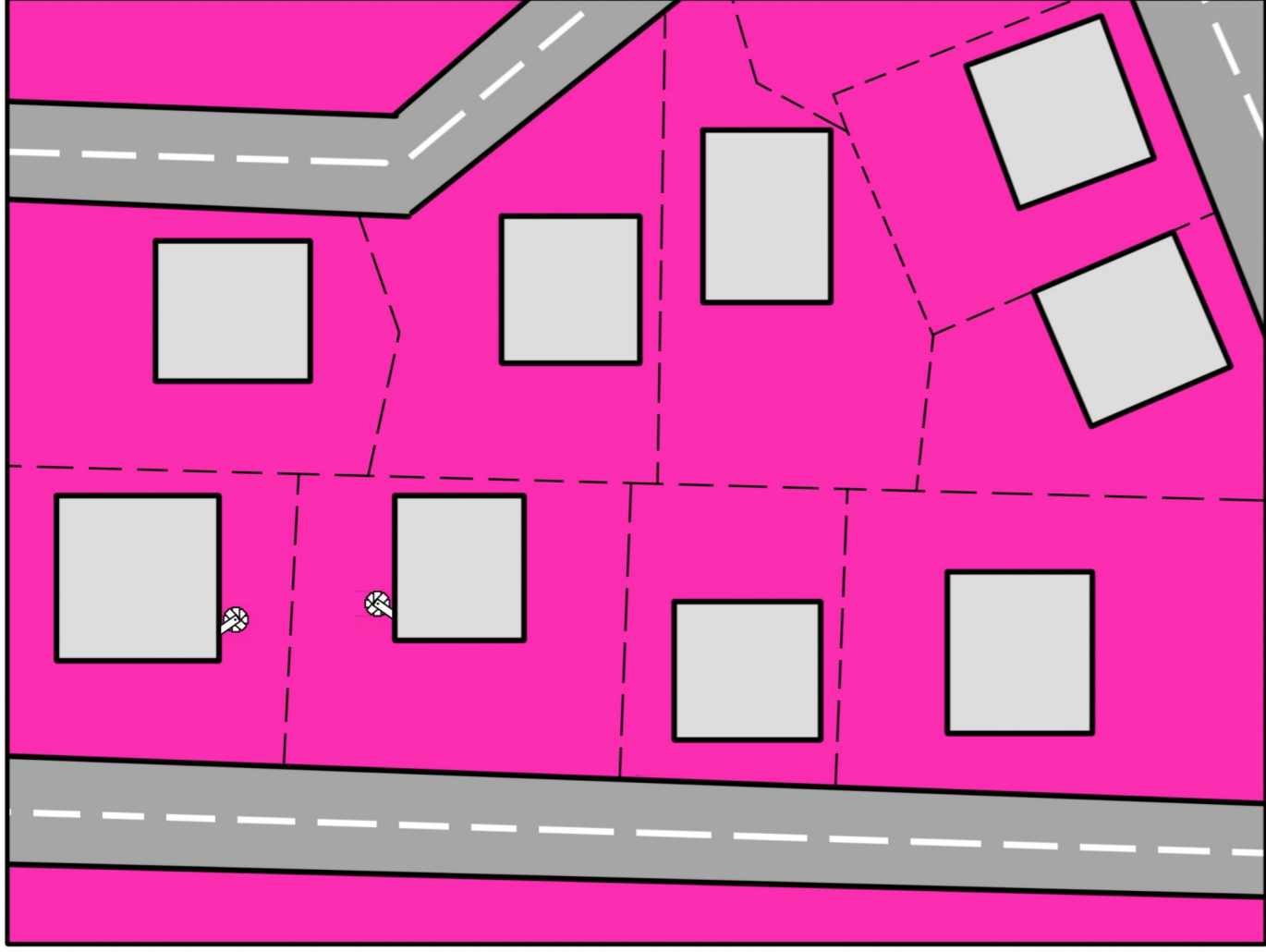

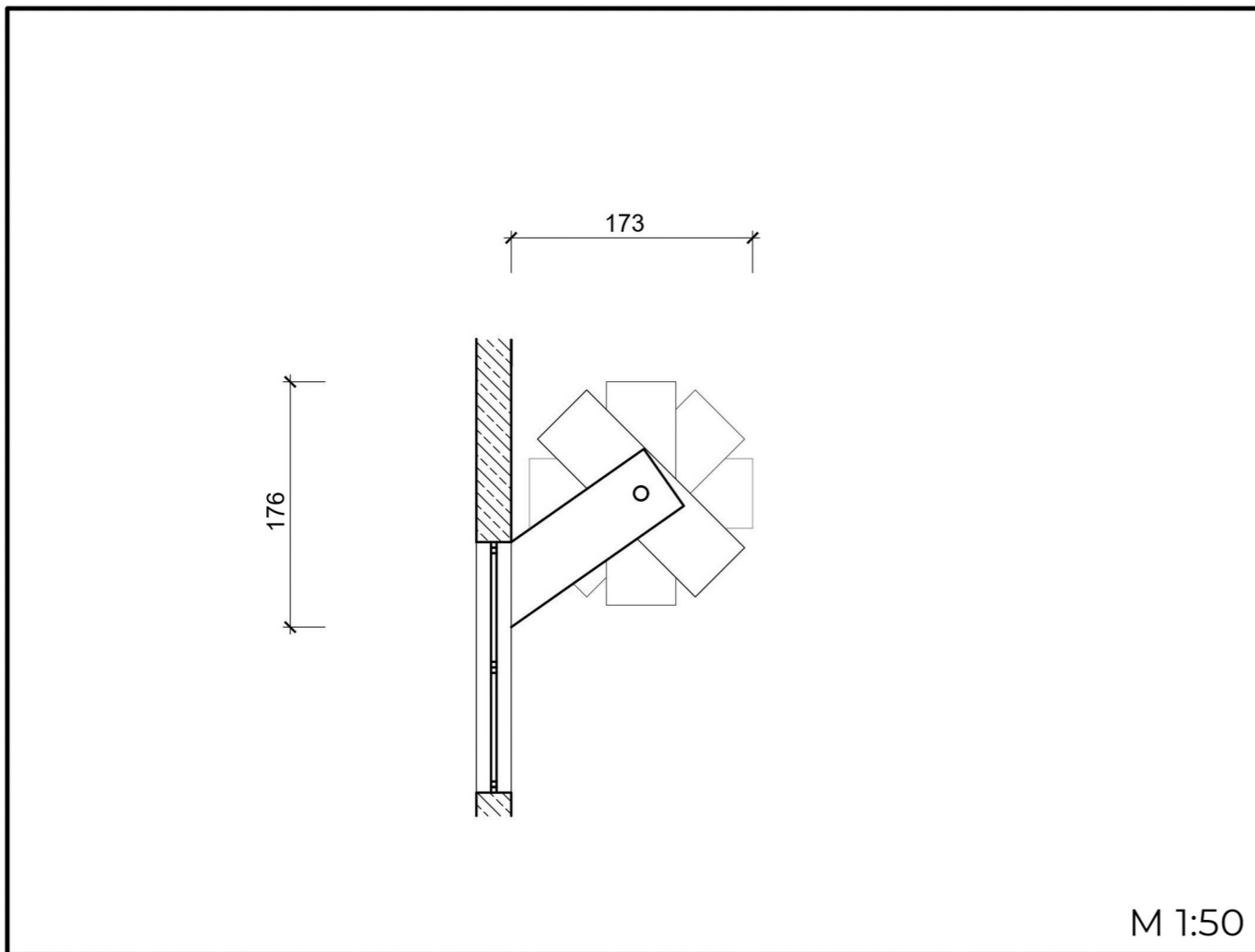
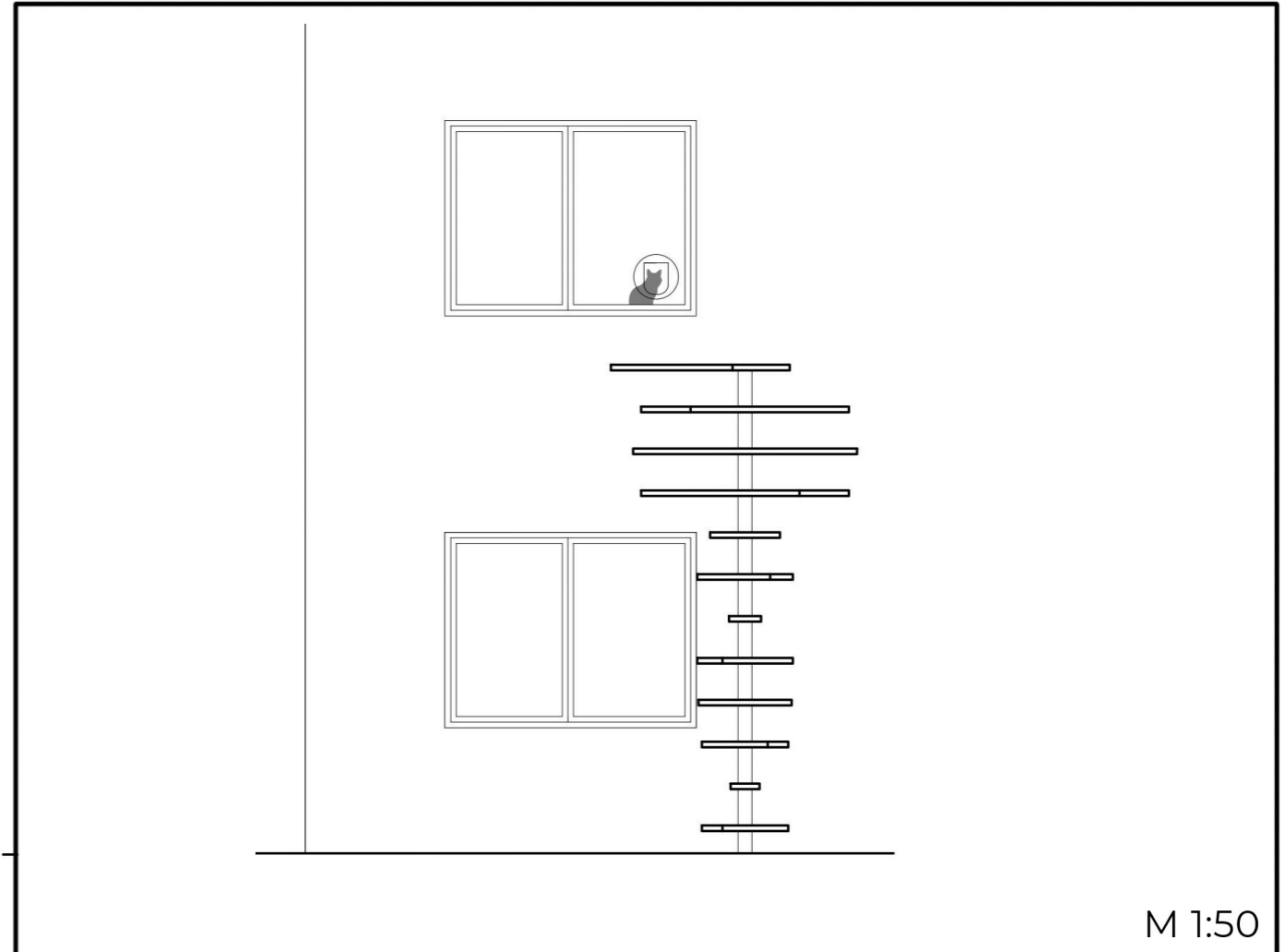
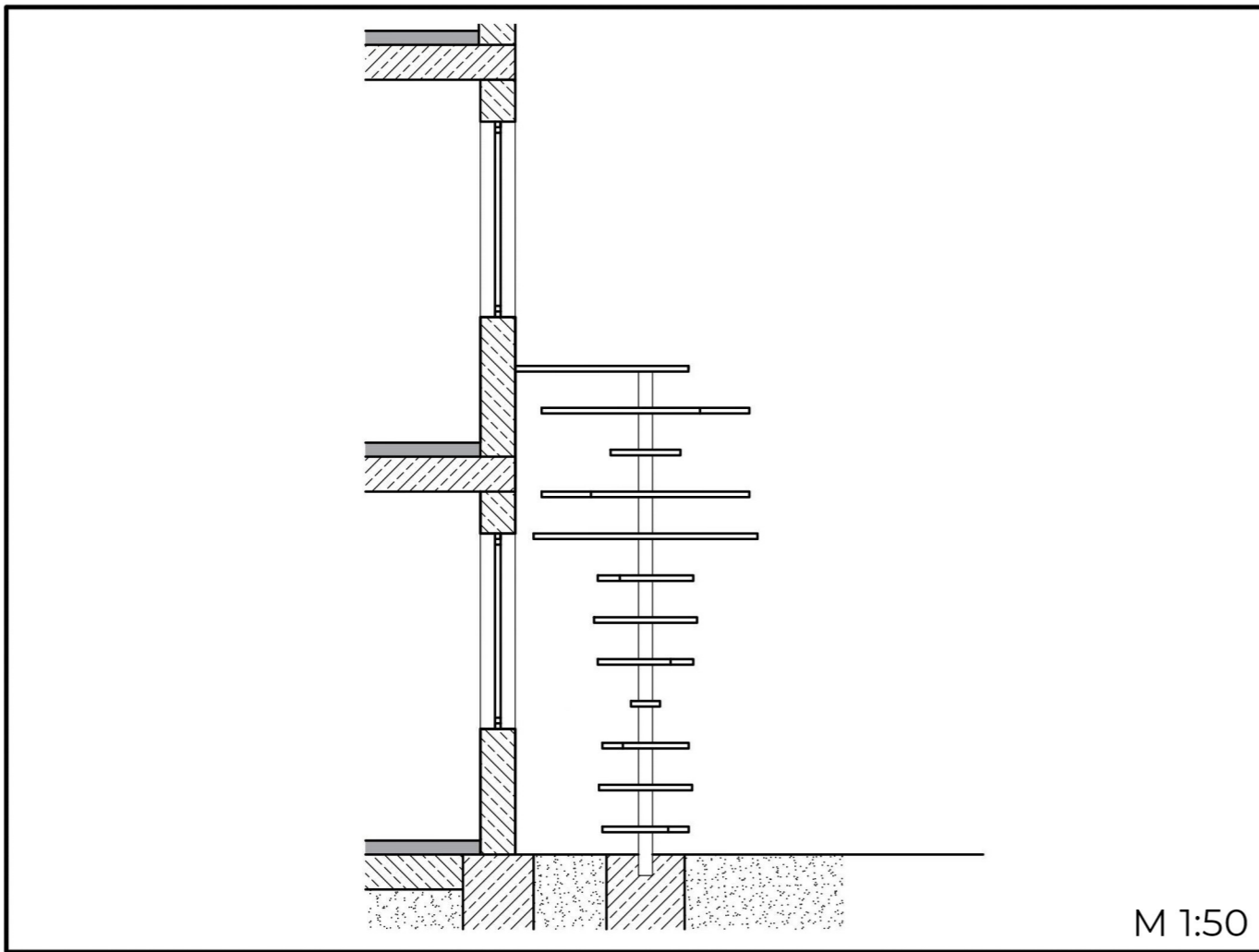

Material
 Lärche, massiv
 Stahl

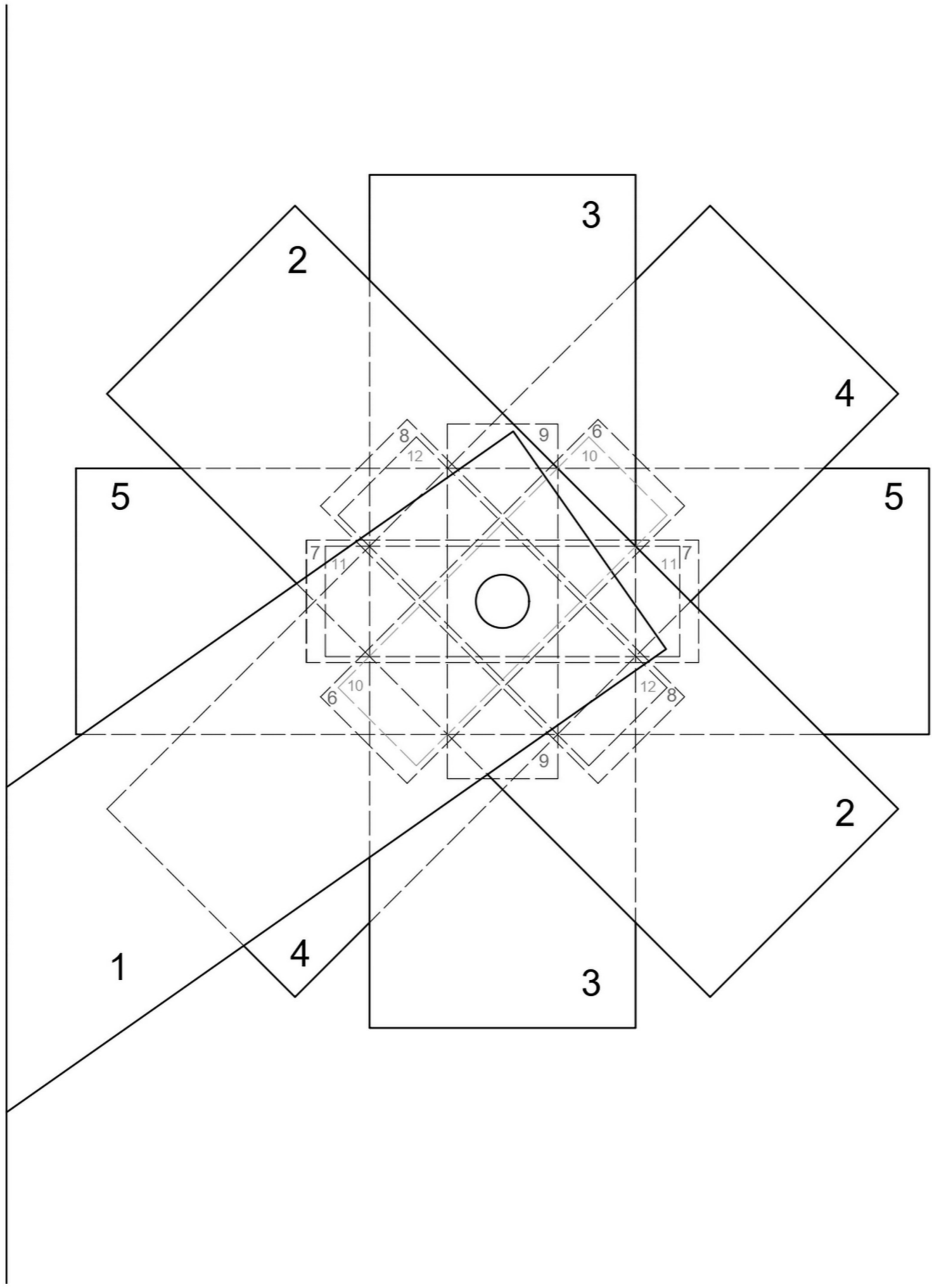

M 1:20

